

EXTERIOR DOORS



The mark of responsible forestry
Look for FSC® certified products

WOODEN EXTERIOR 'P' DOORS



ERKADO is an example of a family business that has been extraordinarily successful on the global market. With bold and determined expansion of the production potential and product portfolio, it is now more and more likely that the door you open is... an ERKADO door.

Since 2010, the ERKADO brand has been known for retail, wholesale and export operations involving the production and sales of internal doors, external doors and frames. With the commissioning of new production facilities and rapid growth of the ERKADO brand, the company was already a leading manufacturer of doors when it celebrated the 40th anniversary of its existence. Innovation, technological flexibility and the ability to rise to new market challenges have allowed the manufacturer to offer high-quality products at reasonable prices. The company was founded by Zbigniew Kozłowski, a master carpenter, who took his first lessons in the craft from his father, also a carpenter. Production began in 1976 in Chwałowice, in the Podkarpackie Voivodeship. Thus, the ERKADO brand builds not only on more than 40 years of experience in the business, but also on the solid foundation of a family tradition.

Initially, the company made doors, windows and other carpentry products for individual customers. This experience was a lesson in the flexibility required to respond to even the most unusual requests from clients. Over time, market trends gave rise to high demand for wooden doors and windows. Top-quality products and satisfied customers. With the implementation of innovative technological solutions, efficient management and prudent investment, the company strengthened its position on the market. It increasingly specialised in the production of external wooden doors and internal panel doors. Subsequent investment in modern machinery allowed the company to take advantage of panel door technology and thus improve the quality of its products. As an industry leader, the company supports many charitable organisations, initiatives and individuals.

BOARD TECHNOLOGY DOORS

The key feature of all P-type exterior doors is the reliable, certified and contemporary technical solution used in production.

This technology allows to preserve the beauty of wooden doors and decors, and to eliminate the majority of problems occurring when applying traditional technologies, these problems are: cracking and moving door coffers, door leaf buckling, uneven colouring of particular door elements, fissuring and veneer waviness as well as problems with joint fillers.

ATTENTION!

- All wood devoted to veneer differ between one another in terms of colour, tint, structure and texture. Such vast differences may occur even among one type of wood and these are the characteristics of natural wood and therefore they cannot be the basis for complaint.
- Individual colour of wood and thickness of surface lacquer have great influence on the final colour of the transparent layer [varnish]
- Presented colours are only of demonstrative character and cannot be treated as the target colour sample
- Due to negative influence of sunlight as well as rain water on all sorts of varnished surfaces it is recommended to apply roofing over the exterior door preferably by constructing an open vestibule.

EXEMPLARY COLOURS ON MERANTI WOOD

WINCHESTER



GOLDEN OAK

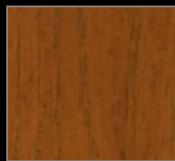

DAR OAK



TEAK

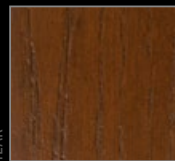

WHITE

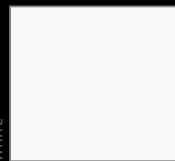

MAHOGANY

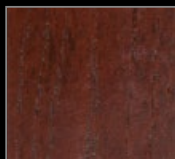

NUT

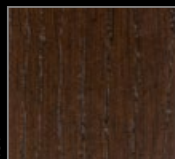

PALSANDER

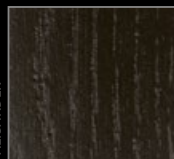

RAL 7016

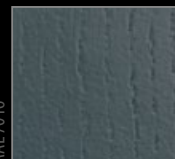

RAL COLOUR PALETTE



DOOR LEAF 72 mm

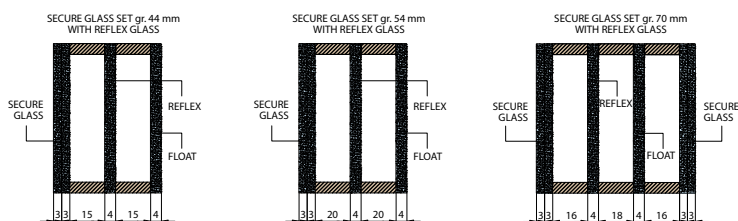
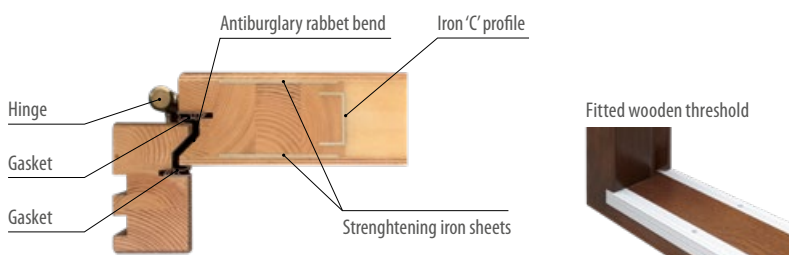
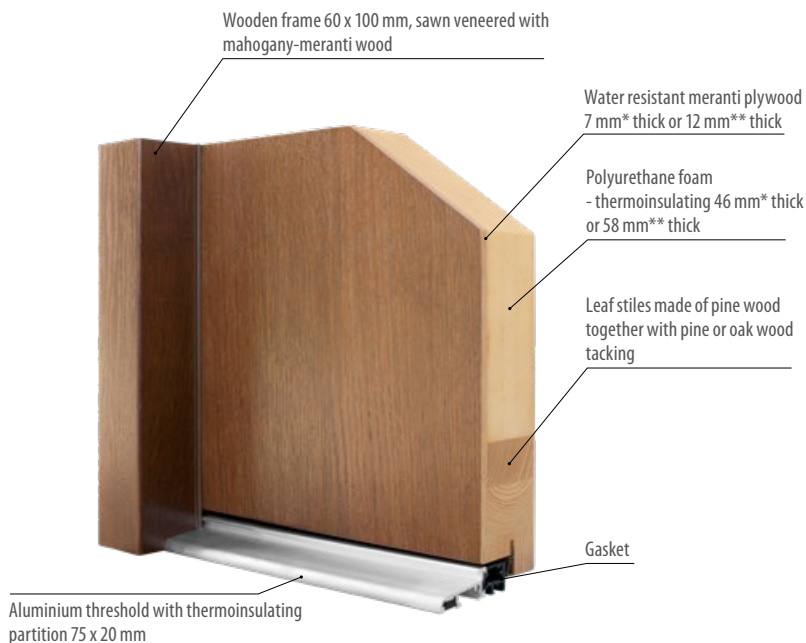

■ Thermal permeability ratio Ud < 0,90 W/m²K

■ Material: oak, pine or meranti

■ Construction

- door thickness 72 mm
- gasket fixed in door leaf and frame
- rebated door leaf
- external sheathing made of watertight oak, pine or meranti plywood of thickness 12 mm or 7 mm
- internal grating with polyurethane foam 58 mm thick [7 mm plywood] and 48 mm thick [12 mm plywood]
- door stile made of pine wood and strengthened with 'C' profile
- rabbet bend from the hinge side

■ Frame

- wood layer-glued together with oak or pine tacking with dimensions 100 mm x 60 mm
- wooden threshold or aluminium threshold with thermal partition

■ Finishing

- triple hydrodynamic coating with water-thinnable paints according to ERKADO palette of colours or RAL colours [extra charged], except RAL 9016 [white] and RAL 70-16 [charcoal]

■ Dimensions

- standard according to the table - page 48
- ERKADO doors are available in non-standard dimensions for no extra charge due to their atypicality.
- The charge concerns only doors: higher than 210 cm and wider than 102 cm.

■ Fittings in standard

- 2 independent pin mortise locks, lock distance 72 mm
- four hinges regulated in three planes
- glass set REFLEX BROWN 44 mm thick [two-chambered] for models: P3, P4, P5, P6, P12, P13, P14, P16, P19, P21, P23, P24, P25, P28, P29, P30, P31, P33, P34, P36, P37, P39, P40, P45, P49, P51, P52, P53, P96, P102, P93, P108, P109, P111, P112, P113, P114, P115, P116, P117, P118, P138, P140, P141, P143, P144
- glass set REFLEX BROWN 54 mm thick [two-chambered] for models: P7, P8, P9, P10, P20, P22, P26, P27, P32, P41, P47, P50, P54, P55, P60, P61, P62, P63, P64, P65, P67, P69, P71, P72, P73, P74, P75, P76, P77, P78, P79, P80, P81, P82, P83, P84, P92, P94, P95, P97, P99, P100, P101, P103, P104, P105, P106, P107, P119, P128, P129, P130, P131, P132, P133, P134, P135, P136, P137, P139, P142, P145, P146, P147, P148, P150
- glass set REFLEX BROWN 70 mm thick [three-chambered] for models: P42, P44, P48, P56, P57, P60, P66, P68, P70, P98, P130, P132, P133, P135, P136
- wooden threshold or aluminium threshold with thermal partition
- decorative stainless iron sheets for models: P42, P44, P46, P48, P57, P58, P66, P68, P70, P81, P95, P97, P98, P99, P100, P101, P102, P103, P104, P105, P106, P128, P129, P130, P131, P132, P133, P134, P135, P136
- glass set with lacquered black glass in models: P120, P121, P122, P123, P124, P125, P126, P127

■ Accessories charged additionally

- door knob
- cylinders 35/65
- door holder
- bio-metric lock
- peephole
- fire alarm switch
- electric strike - only with multi-point lock for 1 or 2 cylinders
- multi-point door lock with one or two cylinders
- gutter drip (doors opening inside)

7 mm* models: P7, P8, P9, P10, P20, P22, P26, P27, P32, P41, P42, P44, P46, P47, P48, P50, P54, P55, P57, P58 P60, P61, P62, P63, P64, P65, P66 P67, P68, P69, P70 P71, P72, P73, P74, P75, P76, P77, P78, P79, P80, P81, P82, P83, P84, P92, P94, P95, P97, P99, P100, P101, P103, P104, P105, P106, P119, P128, P129, P130, P131, P132, P133, P134, P135, P136, P137, P139, P142, P145, P146, P147, P148, P149, P150

12 mm** models: P1, P3, P4, P5, P6, P12, P13, P14, P16, P19, P21, P23, P24, P25, P28, P29, P30, P31, P33, P34, P36, P37, P39, P40, P45, P49, P51, P52, P53, P96, P102, P93, P108, P109, P111, P112, P113, P114, P115, P116, P117, P118, P120, P121, P122, P123, P124, P125, P126, P127, P138, P140, P141, P143, P144

TECHNICAL PARAMETRES

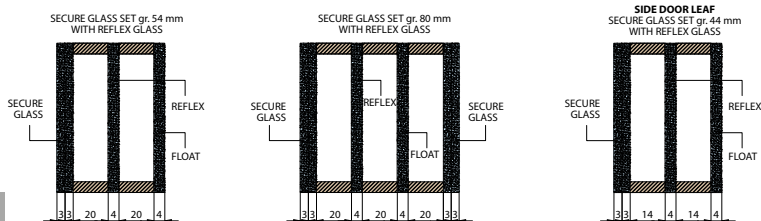
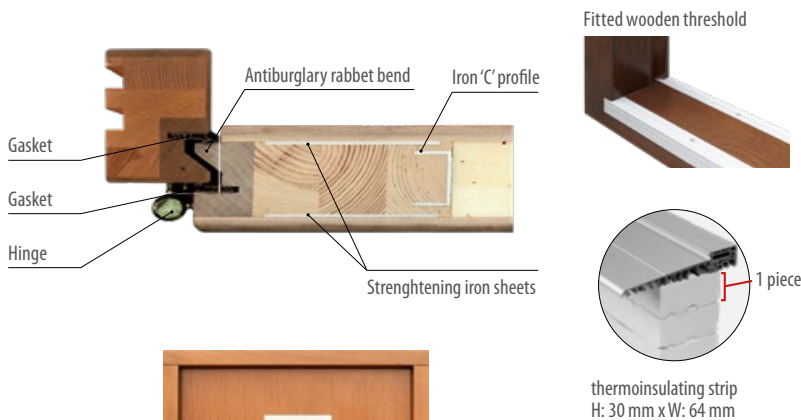
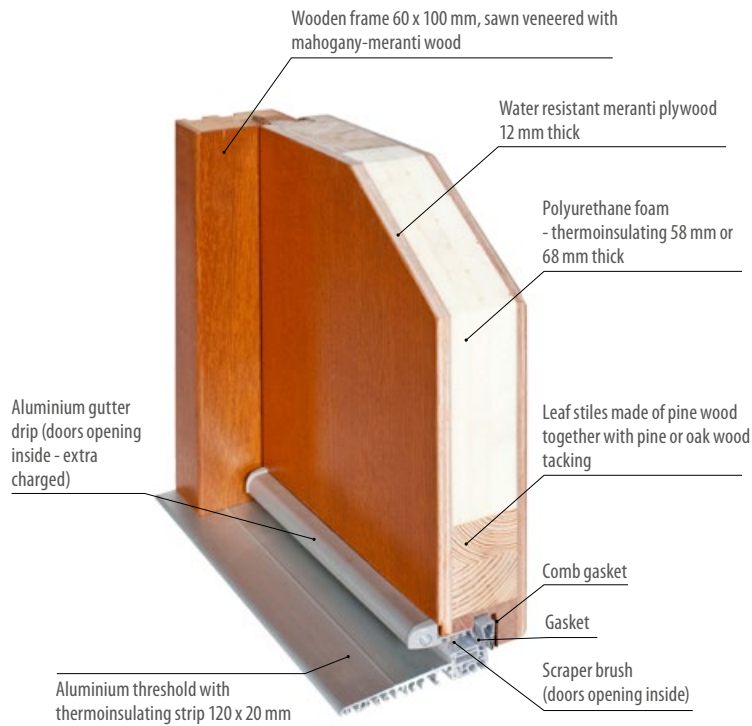

DOOR LEAF 82 mm

■ **Thermal permeability ratio**
 $U_d < 0,78 \text{ W/m}^2\text{K}$

■ **Material: oak, pine or meranti**

■ **Construction**

- door thickness 82 mm
- gasket fixed in door leaf and frame
- rebated door leaf
- external sheathing made of watertight mahogany meranti plywood oak or pine plywood of thickness 12 mm [mahogany-meranti], 7 mm and 12 mm [oak or pine]
- internal grating with polyurethane foam 58 mm thick
- door stile made of pine meranti wood and strengthened with 'C' profile
- rabbet bend from the hinge side

■ **Frame**

- wood layer-glued together with mahogany meranti tacking with dimensions 100 mm x 60 mm
- wooden threshold or aluminium threshold with thermal partition

■ **Finishing**

- triple hydrodynamic coating with water-thinnable paints according to ERKADO palette of colours or RAL colours [extra charged], except RAL 9016 [white] and RAL 70-16 [charcoal] - page 49

■ **Dimensions**

- standard according to the table - page 48
- ERKADO doors are available in non-standard dimensions for no extra charge due to their atypicality. The charge concerns only doors: higher than 210 cm and wider than 102 cm.

■ **Fittings in standard**

- multi-point lock with 1 cylinder, lock distance 72 mm
- four hinges regulated in three planes
- glass set REFLEX BROWN 54 mm thick [two-chambered]: P3, P4, P5, P6, P12, P13, P14, P16, P19, P21, P23, P24, P25, P28, P29, P30, P31, P33, P34, P36, P37, P39, P40, P45, P49, P51, P52, P53, P96, P102, P93, P108, P109, P111, P112, P113, P114, P115, P116, P117, P118, P138, P140, P141, P143, P144
- glass set REFLEX BROWN 64 mm thick [two-chambered] for models: P7, P8, P9, P10, P20, P22, P26, P27, P32, P41, P47, P50, P54, P55, P60, P61, P62, P63, P64, P65, P67, P69, P71, P72, P73, P74, P75, P76, P77, P78, P79, P80, P81, P82, P83, P84, P92, P94, P95, P97, P99, P100, P101, P103, P104, P105, P106, P107, P119, P128, P129, P130, P131, P132, P133, P134, P135, P136, P137, P139, P142, P145, P146, P147, P148, P150
- glass set REFLEX BROWN 80 mm thick [three-chambered] for models: P42, P44, P48, P56, P57, P60, P66, P68, P70, P98, P130, P132, P133, P135, P136
- aluminium threshold with thermal partition
- decorative stainless iron sheets for models: P42, P44, P46, P48, P57, P58, P60, P66, P68, P70, P81, P95, P97, P98, P99, P100, P101, P102, P103, P104, P105, P106, P128, P129, P130, P131, P132, P133, P134, P135, P136
- glass set with lacquered black glass in models: P120, P121, P122, P123, P124, P125, P126, P127

■ **Accessories charged additionally**

- door knob
- cylinders 45/65
- door holder
- bio-metric lock
- peephole
- fire alarm switch
- electric strike
- multi-point lock for two cylinders
- thermoinsulating strip (threshold)
- gutter drip (doors opening inside)

PASSIVE DOORS

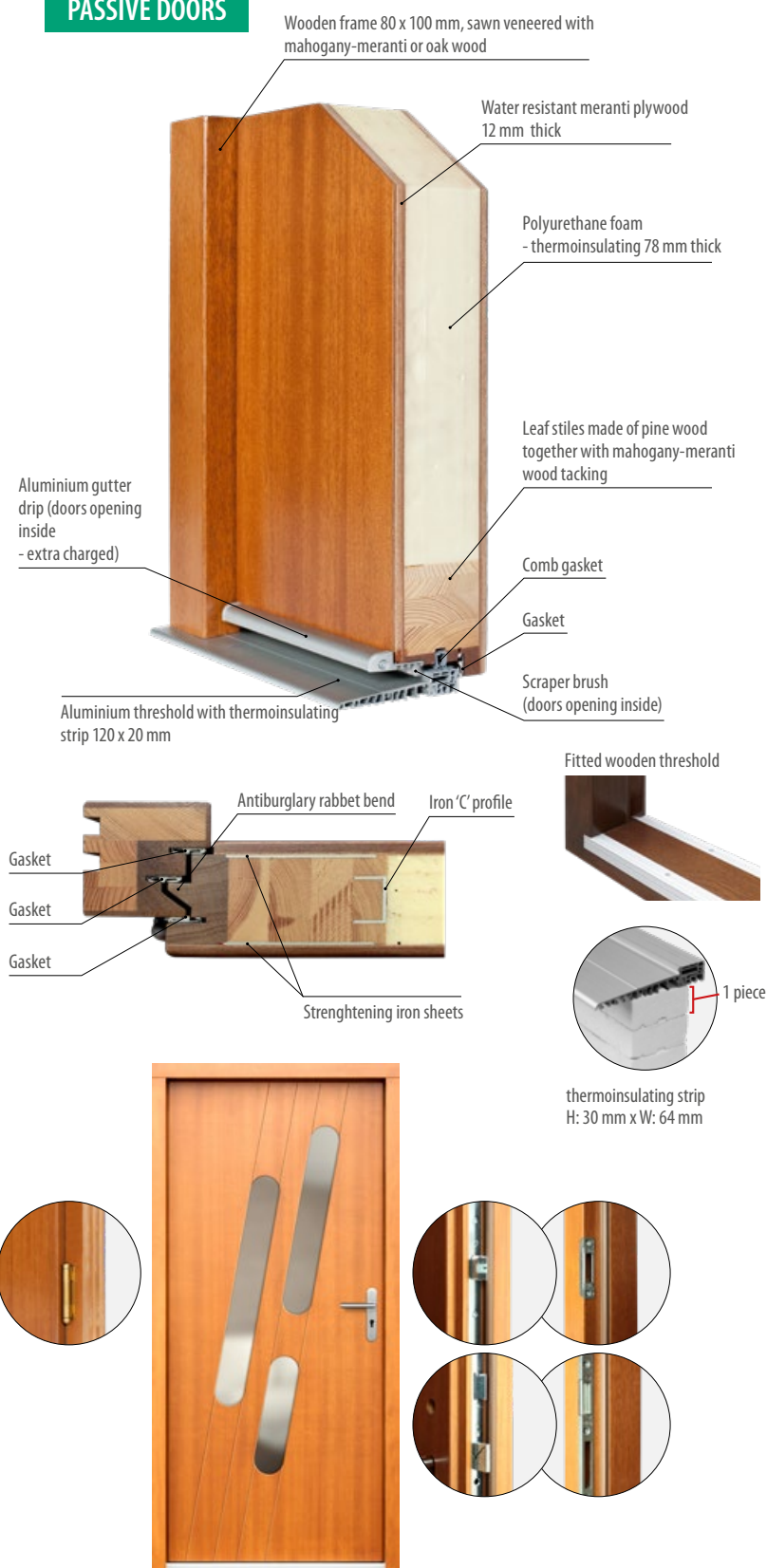

DOOR LEAF 102 mm

■ Thermal permeability ratio
 $U_d = 0,63 \text{ W/m}^2\text{K}$

■ Material: meranti or oak

Construction

- door thickness 102 mm
- gasket fixed in door leaf and frame
- rebated door leaf
- external sheathing made of watertight mahogany meranti plywood or pine plywood of thickness 12 mm [mahogany-meranti], 7 mm and 12 mm [oak or pine]
- internal grating with polyurethane foam 78 mm thick
- door stile made of pine meranti wood and strengthened with 'C' profile
- rabbet bend from the hinge side

Frame

- wood layer-glued together with mahogany meranti tacking with dimensions 100 mm x 80 mm
- wooden threshold or aluminium threshold with thermal partition

Finishing

- triple hydrodynamic coating with water-thinnable paints according to ERKADO palette of colours or RAL colours [extra charged], except RAL 9016 [white] and RAL 70-16 [charcoal] - page 49

Dimensions

- standard according to the table - page 48
- ERKADO doors are available in non-standard dimensions for no extra charge due to their atypicality. The charge concerns only doors: higher than 212 cm and wider than 106 cm.

Fittings in standard

- multi-point lock with 1 cylinder, lock distance 92 mm
- three hinges regulated in three planes - 3D
- glass set REFLEX BROWN 72 mm thick [three-chambered]
- glass set REFLEX BROWN 100 mm thick [four-chambered] for models: P42, P44, P48, P57, P66, P68, P70, P98, P130, P132, P133, P135, P136
- aluminium threshold with thermal partition
- decorative stainless iron sheets for models: P42, P44, P46, P48, P57, P58, P66, P68, P70, P81, P82, P95, P97, P98, P99, P100, P101, P102, P103, P104, P105, P106, P128, P129, P130, P131, P132, P133, P134, P135, P136

Accessories charged additionally

- door knob
- cylinders 60/65
- door holder
- bio-metric lock
- multi-point door lock with one or two cylinders
- peephole
- electric strike
- thermoinsulating strip (threshold)
- gutter drip (doors opening inside)
- fered alarm switch

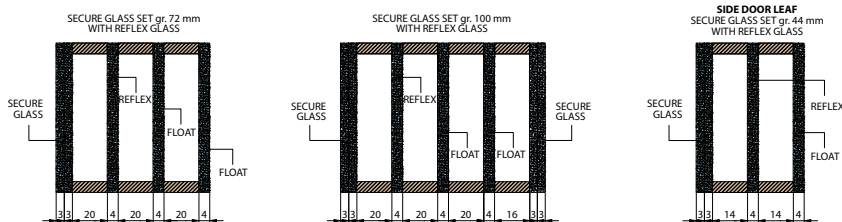

EXTERIOR NON-REBATED DOOR LEAF 102 mm

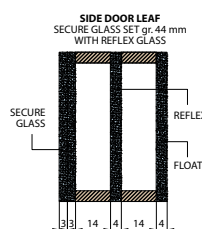
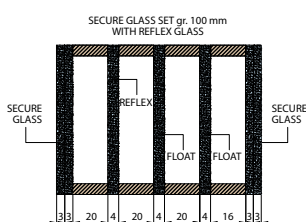
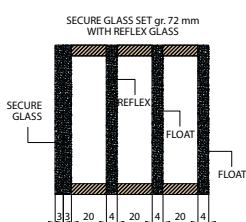
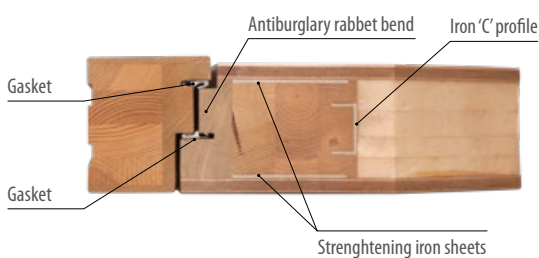
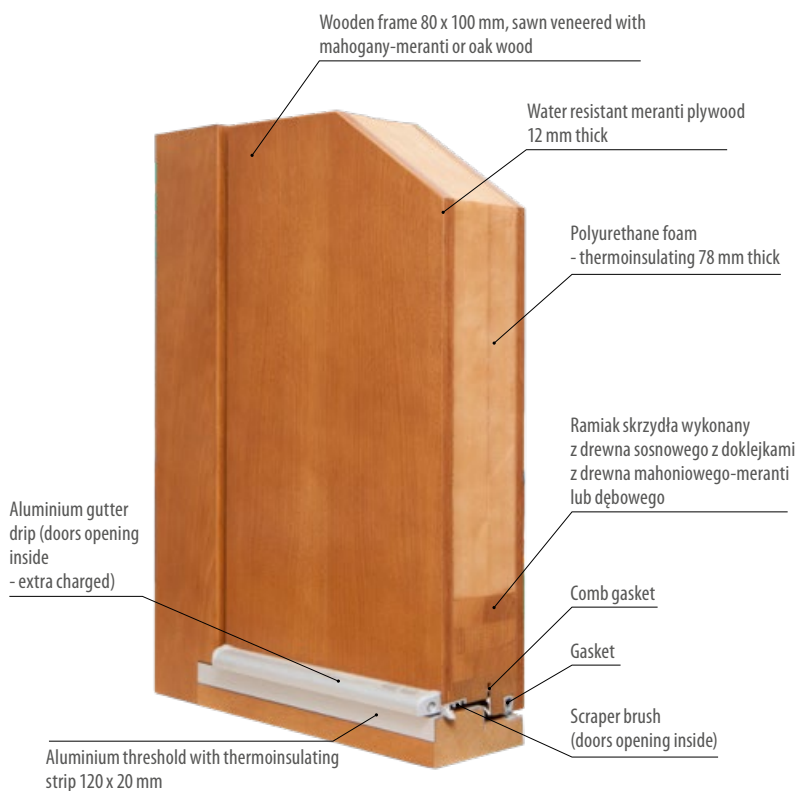

■ Thermal permeability ratio

$U_d = 0,64 \text{ W/m}^2\text{K}$

■ Material: meranti or oak

■ Construction

- door thickness 102 mm
- gasket fixed in door leaf and frame
- non-rebated door leaf
- external sheathing made of watertight mahogany meranti plywood oak or pine plywood of thickness 12 mm [mahogany-meranti]
- internal grating with polyurethane foam 78 mm thick
- door stile made of pine meranti wood and strenghtened with 'C' profile
- three hidden hinges
- rabbet bend from the hinge side

■ Frame

- wood layer-glued together with mahogany meranti tacking with dimensions 100 mm x 80 mm
- wooden threshold

■ Finishing

- triple hydrodynamic coating with water-thinnable paints according to ERKADO palette of colours or RAL colours [extra charged], except RAL 9016 [white] and RAL 70-16 [charcoal] - page 49

■ Dimensions

- standard according to the table - page 48
- ERKADO doors are available in non-standard dimensions for no extra charge due to their atypicality. The charge concerns only doors: higher than 212 cm and wider than 106 cm.

■ Fittings in standard

- multi-point lock with 1 cylinder, lock distance 72 mm
- three hinges regulated in three planes - 3D
- glass set REFLEX BROWN 74 mm thick [three-chambered]
- glass set REFLEX BROWN 100 mm thick [four-chambered] for models: P42, P44, P48, P57, P66, P68, P70, P98, P130, P132, P133, P135, P136
- aluminium threshold with thermal partition
- decorative stainless iron sheets for models: P42, P44, P46, P48, P57, P58, P66, P68, P70, P81, P82, P95, P97, P98, P99, P100, P101, P102, P103, P104, P105, P106, P128, P129, P130, P131, P132, P133, P134, P135, P136

■ Accessories charged additionally

- door knob
- cylinders 60/65
- door holder
- bio-metric lock
- multi-point door lock with one or two cylinders
- peephole
- electric strike
- thermoinsulating strip (threshold)
- gutter drip (doors opening inside)
- fereed alarm switch

■ TYPES OF APPLICABLE GLAZING

[REFLEX SET IN STANDARD]

ANTISOL

It is visor glass, delicately tinted brown that decreases the permeability of solar energy. Thanks to this, it prevents interiors from heating up. What is more, it protects the objects sensitive to UV light.

REFLEX (stopsol)

It is the glass of enhanced sun light control. It improves visual effect and gives a feeling of privacy. This effect is the result of applying metal oxides on one side of glass. People looking at the glass from the brighter side of mirror see their reflexion and are visible to people being on the darker side. Only when approaching the glass closely from the brighter side one can notice objects on the darker side.

TWO-WAY MIRROR [phoenician]

It is glass covered on both sides with metal oxides. Usually it is exploited as the partition between the rooms one of which is darkened. People staying on the lighter side of the mirror can see their own reflexion and are visible to people staying on the darker side.

MILK GLASS

It is glass that is covered with satin-frosted lacquer thanks to which it allows light through but becomes opaque.

ANTIBURGLARY GLASS P4

It consists of two layers of colourless glass between which there is antiburglary foil. Thanks to the foil, in case of hitting the glass, it breaks into tiny pieces and at the very place of contact the cracks go stellately. P4 glass is available only as transparent.

SECURE GLASS 331

It is glass that reduces to minimum the health risk for people staying in glazed rooms. The risk can include the shards of broken glass as well as fire, gas or heat radiation - symptoms of fire. The glass is called 'secure' provided that the technology of its production or connections allow to reduce damage resulting from possible deformation, impact or fire.

The mark 331 stands for the glazing consisting of two sheets of glass, each 3 mm thick, and one layer of foil. Secure glass 331 belongs to the 02 grade glass. It is most often used in apartments, schools, offices. It guarantees protection against injuries and also can be applied in the buildings vulnerable to interior explosion threat.

SANDBLASTED GLASS

It is glass that undergoes the mechanical process of frosting by means of sand blasting under high pressure.

This process enables to decorate the glass with any pattern available in our catalogue or individual projects provided by the Client. The final effect can be frosted pattern or reversely - smart transparent design.



EXTERIOR DOOR COLLECTION



■ P1 page 38



■ P2 page 38



■ P3 page 37



■ P4 page 38



■ P5 page 37



■ P6 page 35

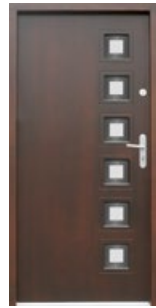

■ P7 page 25



■ P8 page 29



■ P9 page 29



■ P10 page 29



■ P11 page 38



■ P12 page 35



■ P13 page 35



■ P14 page 35



■ P15 page 38



■ P16 page 37



■ P17 page 39



■ P18 page 39



■ P19 page 37



■ P20 page 26



■ P21 page 29



■ P22 page 24



■ P23 page 36



■ P24 page 30



■ P25 page 30



■ P26 page 31



■ P27 page 24



■ P28 page 30



■ P29 page 35



■ P30 page 36



■ P31 page 33



■ P32 page 34



■ P33 page 37



■ P34 page 24



■ P35 page 38



■ P36 page 35



■ P37 page 29



■ P38 page 39



■ P39 page 36



■ P40 page 30



■ P41 page 26



■ P42 page 18

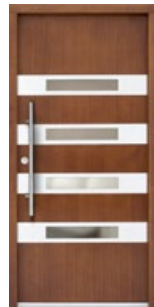

■ P44 page 19



■ P45 page 37

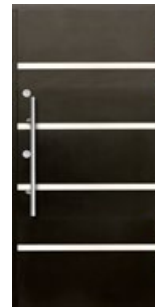

■ P46 page 21



■ P47 page 29



■ P48 page 18



■ P49 page 36



■ P50 page 24



■ P51 page 36

EXTERIOR DOOR COLLECTION



■ P52 page 36



■ P53 page 26



■ P54 page 33



■ P55 page 25



■ P56 page 22



■ P57 page 18



■ P58 page 17



■ P59 page 39



■ P60 page 19



■ P61 page 28



■ P62 page 28



■ P63 page 31



■ P64 page 22



■ P65 page 31



■ P66 page 20



■ P67 page 31



■ P68 page 19



■ P69 page 25



■ P70 page 18



■ P71 page 25



■ P72 page 30



■ P73 page 28



■ P92 page 25



■ P93 page 30



■ P94 page 25



■ P95 page 20

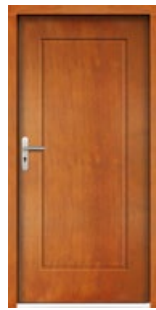

■ P96 page 39



■ P97 page 17



■ P74 page 28



■ P75 page 28



■ P76 page 28



■ P77 page 31



■ P78 page 24



■ P79 page 26



■ P80 page 24



■ P81 page 19



■ P82 page 21



■ P83 page 26



■ P84 page 26



■ P85 page 40



■ P86 page 40



■ P87 page 40

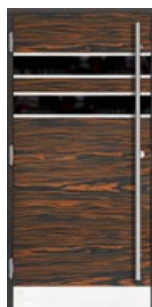

■ P88 page 40



■ P89 page 20



■ P90 page 20



■ P91 page 19



■ P98 page 18



■ P99 page 19



■ P100 page 21



■ P101 page 21

EXTERIOR DOOR COLLECTION



■ P102 page 20



■ P103 page 20



■ P104 page 21



■ P105 page 21



■ P106 page 18



■ P107 page 27



■ P108 page 27



■ P109 page 27



■ P110 page 39



■ P111 page 33



■ P112 page 33



■ P113 page 35



■ P114 page 35



■ P115 page 35



■ P116 page 33



■ P117 page 33



■ P118 page 27



■ P119 page 31



■ P120 page 14



■ P121 page 14



■ P122 page 14



■ P123 page 14



■ P124 page 14



■ P125 page 14



■ P126 page 15



■ P127 page 15



■ P128 page 16



■ P129 page 16



■ P130 page 16



■ P131 page 16



■ P132 page 16



■ P133 page 16



■ P134 page 17



■ P135 page 22



■ P136 page 22



■ P137 page 23



■ P138 page 23



■ P139 page 23



■ P140 page 27



■ P141 page 27



■ P142 page 32



■ P143 page 32



■ P144 page 32



■ P145 page 32



■ P146 page 32

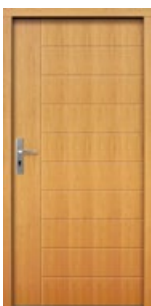

■ P147 page 32



■ P148 page 34

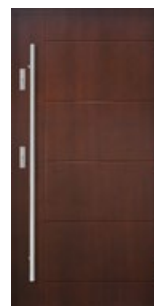

■ P149 page 34



■ P150 page 22

GLASS

EXTERIOR DOOR COLLECTION



■ P120



■ P121



■ P122



■ P123

– pochwyt za dopłatą



■ P124



■ P125

ERKADO doors are available in non-standard dimensions for no extra charge due to their atypicality. The charge concerns only doors: higher than 210 cm and wider than 102 cm (for 72 and 82 mm thick). Lacquered glass comes only on the outside.



■ P126



■ P127



INOX

EXTERIOR DOOR COLLECTION



■ P128

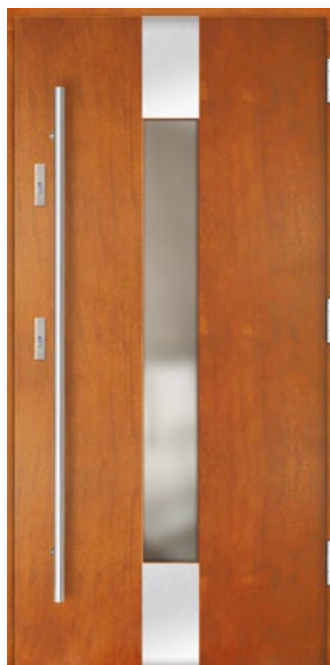

■ P129



■ P130



■ P131



■ P132



■ P133

ERKADO doors are available in non-standard dimensions for no extra charge due to their atypicality. The charge concerns only doors: higher than 210 cm and wider than 102 cm (for 72 and 82 mm thick).



■ P134



■ P58



■ P97



INOX

EXTERIOR DOOR COLLECTION



■ P42



■ P98



■ P48



■ P70



■ P57



■ P106

ERKADO doors are available in non-standard dimensions for no extra charge due to their atypicality. The charge concerns only doors: higher than 210 cm and wider than 102 cm (for 72 and 82 mm thick).



■ P99



■ P60



■ P68



■ P44

ATTENTION: P44 doors are available only with multi-point lock with 1 cylinder and double-side holder



■ P91

ATTENTION: P44 doors are available only with multi-point lock with 1 cylinder



■ P81

INOX

EXTERIOR DOOR COLLECTION



■ P66



■ P89



■ P90



■ P103



■ P102



■ P95

ERKADO doors are available in non-standard dimensions for no extra charge due to their atypicality. The charge concerns only doors: higher than 210 cm and wider than 102 cm (for 72 and 82 mm thick).



■ P101



■ P82



■ P104



■ P46



■ P105



■ P100

INOX

EXTERIOR DOOR COLLECTION



■ P135



■ P136



■ P150



■ P64



■ P56

ERKADO doors are available in non-standard dimensions for no extra charge due to their atypicality. The charge concerns only doors: higher than 210 cm and wider than 102 cm (for 72 and 82 mm thick).

MODERN

EXTERIOR DOOR COLLECTION

ERKADO



■ P137



■ P138



■ P139

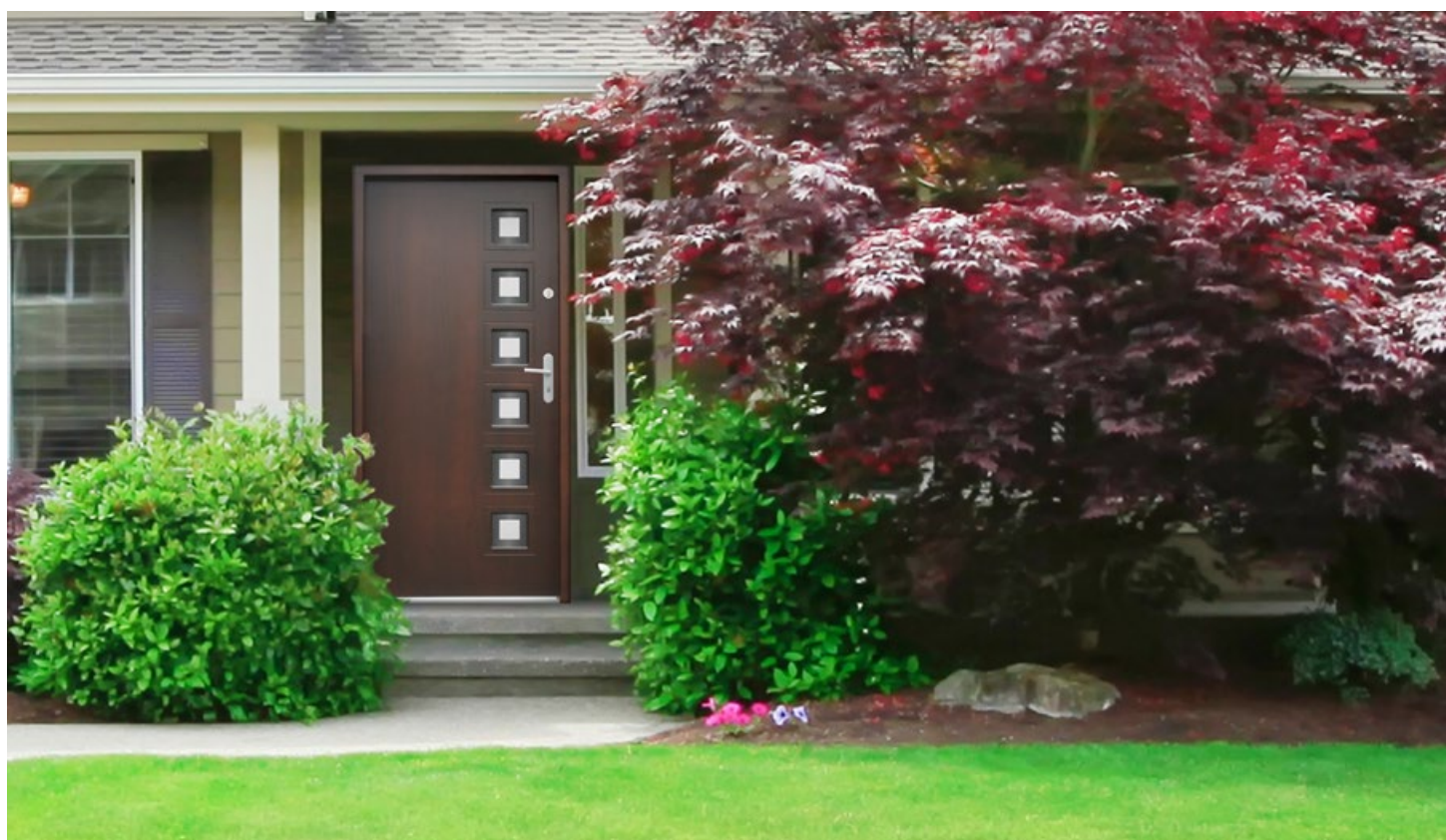

ERKADO doors are available in non-standard dimensions for no extra charge due to their atypicality. The charge concerns only doors: higher than 210 cm and wider than 102 cm (for 72 and 82 mm thick).

MODERN

EXTERIOR DOOR COLLECTION



■ P80



■ P50



■ P22



■ P27



■ P78



■ P34

ERKADO doors are available in non-standard dimensions for no extra charge due to their atypicality. The charge concerns only doors: higher than 210 cm and wider than 102 cm (for 72 and 82 mm thick).



■ P55



■ P94



■ P92



■ P71



■ P69



■ P7

MODERN

EXTERIOR DOOR COLLECTION



■ P84



■ P83



■ P79



■ P53



■ P41

– this model is available only in RAL paints



■ P20

ERKADO doors are available in non-standard dimensions for no extra charge due to their atypicality. The charge concerns only doors: higher than 210 cm and wider than 102 cm (for 72 and 82 mm thick).



■ P140



■ P141



■ P118



■ P107



■ P108



■ P109

MODERN

EXTERIOR DOOR COLLECTION



■ P75



■ P61



■ P76



■ P73

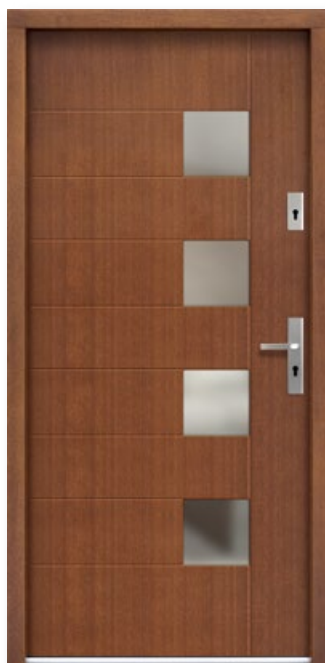

■ P74



■ P62

ERKADO doors are available in non-standard dimensions for no extra charge due to their atypicality. The charge concerns only doors: higher than 210 cm and wider than 102 cm (for 72 and 82 mm thick).



■ P8



■ P9



■ P21



■ P47



■ P37



■ P10

MODERN

EXTERIOR DOOR COLLECTION



■ P24



■ P25



■ P40



■ P72



■ P28



■ P93

ERKADO doors are available in non-standard dimensions for no extra charge due to their atypicality. The charge concerns only doors: higher than 210 cm and wider than 102 cm (for 72 and 82 mm thick).



■ P77



■ P67



■ P119



■ P63



■ P65



■ P26

CLASSICAL

EXTERIOR DOOR COLLECTION



■ P142



■ P143



■ P144



■ P145



■ P146



■ P147

ERKADO doors are available in non-standard dimensions for no extra charge due to their atypicality. The charge concerns only doors: higher than 210 cm and wider than 102 cm (for 72 and 82 mm thick).



■ P54



■ P111



■ P112



■ P116



■ P117



■ P31

CLASSICAL

EXTERIOR DOOR COLLECTION



■ P113



■ P114



■ P115



■ P148



■ P32



■ P149

ERKADO doors are available in non-standard dimensions for no extra charge due to their atypicality. The charge concerns only doors: higher than 210 cm and wider than 102 cm (for 72 and 82 mm thick).



■ P13



■ P14



■ P36



■ P12



■ P6



■ P29

CLASSICAL

EXTERIOR DOOR COLLECTION



■ P51



■ P30



■ P39

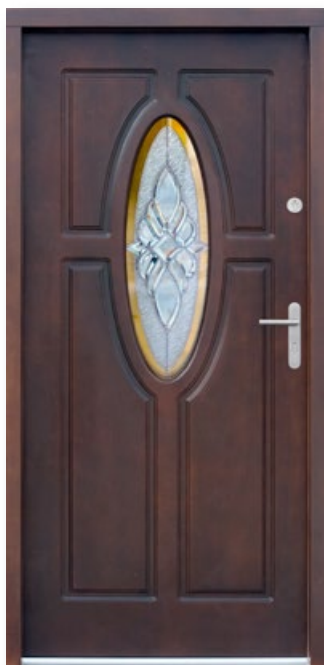

■ P52



■ P23



■ P49

ERKADO doors are available in non-standard dimensions for no extra charge due to their atypicality. The charge concerns only doors: higher than 210 cm and wider than 102 cm (for 72 and 82 mm thick).



■ P5



■ P3



■ P45



■ P19



■ P33



■ P16

CLASSICAL

EXTERIOR DOOR COLLECTION



■ P4



■ P1



■ P11



■ P2



■ P15



■ P35

ERKADO doors are available in non-standard dimensions for no extra charge due to their atypicality. The charge concerns only doors: higher than 210 cm and wider than 102 cm (for 72 and 82 mm thick).



■ P38

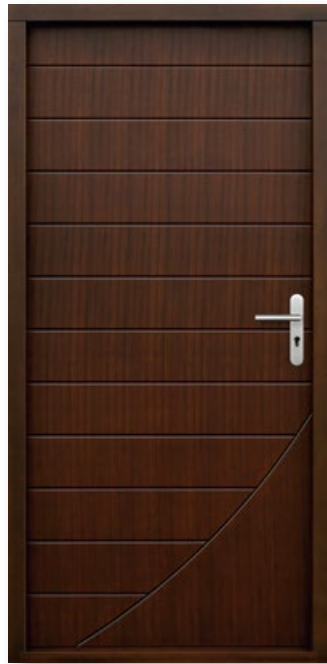

■ P59



■ P96



■ P18



■ P17



■ P110

DEKOR

EXTERIOR DOOR COLLECTION



■ P85
– holder is additionally charged

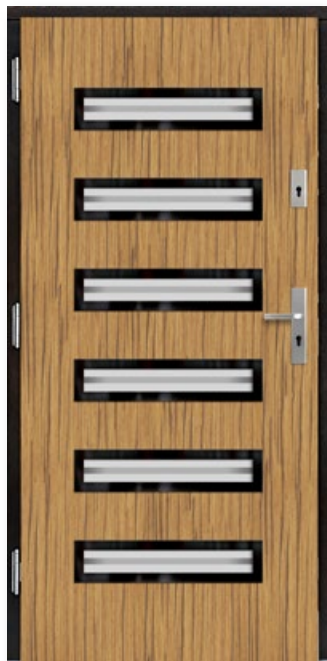

■ P86

MASKAR EBONY

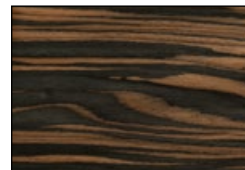

BLACK&WHITE EBONY

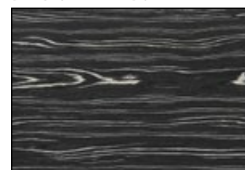

BURMA TEAK

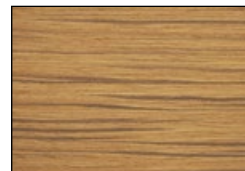

MADAGASKAR ROSEWOOD

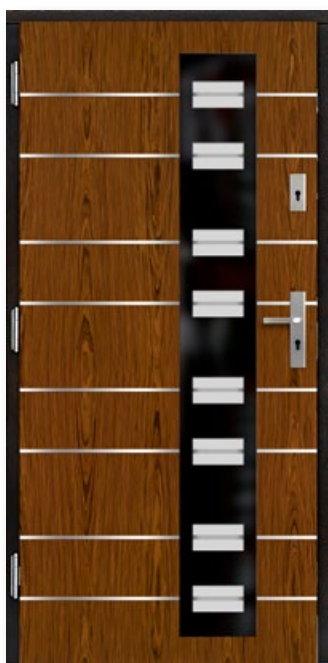

■ P87

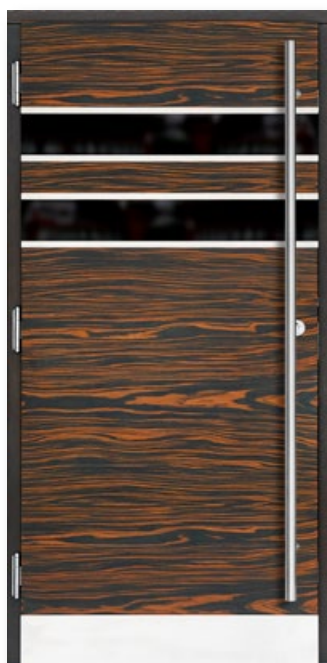

■ P88

– holder is additionally charged

- the above decors come only on one side
- decors with glass and stainless steel appear on the exterior side of door leaf
- available only 4 types of veneer:
 - MASKAR EBONY
 - BLACK&WHITE EBONY
 - MADAGASKAR ROSEWOOD
 - BURMA TEAK
- mahogany frame painted rosewood

ERKADO doors are available in non-standard dimensions for no extra charge due to their atypicality. The charge concerns only doors: higher than 210 cm and wider than 102 cm (for 72 and 82 mm thick).

EXPANSION CAPABILITIES

The modern and classical collection of ERKADO exterior doors can be expanded by constructing accordant and compatible sidelights and toplights as well as side door leaves. Their design and price are discussed individually.



P37 + FIXED SIDE DOOR LEAF [IMITATING DOOR LEAF]

Door width (cm)	Door height (cm)	
	with aluminium threshold	with wooden threshold
160	208,2	210

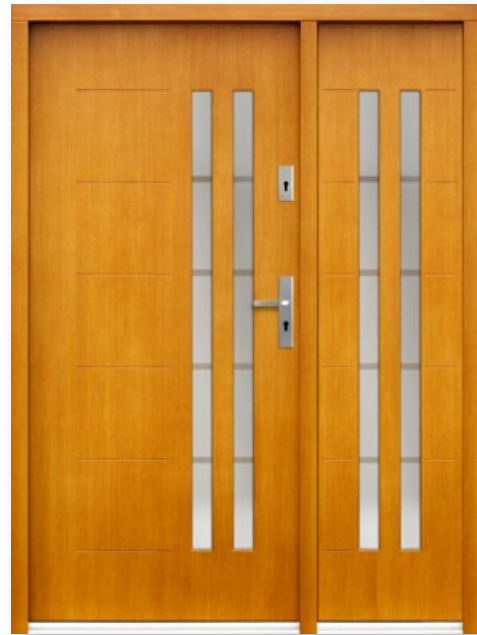

P82 + FIXED SIDE DOOR LEAF [IMITATING DOOR LEAF]

Door width (cm)	Door height with wooden threshold (cm)
160	210



P99 + FIXED SIDE DOOR LEAF [IMITATING DOOR LEAF]

Door width (cm)	Door height (cm)	
	with aluminium threshold	with wooden threshold
160	208,2	210



P105 + FIXED GLASS IN-FRAME SIDE DOOR LEAF

Door width (cm)	Door height (cm)	
	with aluminium threshold	with wooden threshold
160	208,2	210

ERKADO doors are available in non-standard dimensions for no extra charge due to their atypicality. The charge concerns only doors: higher than 210 cm and wider than 102 cm (for 72 and 82 mm thick). Attention: side light imitation of a door leaf is fixed on hinges.

EXPANSION CAPABILITIES



P67 + FIXED SIDE DOOR LEAF [IMITATING DOOR LEAF]

Door width (cm)	Door height (cm)	
	with aluminium threshold	with wooden threshold
160	208,2	210



P89 + FIXED SIDE DOOR LEAF [IMITATING DOOR LEAF]

Door width (cm)	Door height (cm)	
	with aluminium threshold	with wooden threshold
160	208,2	210



P65 + FIXED SIDE DOOR LEAF [IMITATING DOOR LEAF]

Door width (cm)	Door height (cm)	
	with aluminium threshold	with wooden threshold
160	208,2	210



P25 + FIXED SIDE DOOR LEAF [IMITATING DOOR LEAF]

Door width (cm)	Door height (cm)	
	with aluminium threshold	with wooden threshold
160	208,2	210

ERKADO doors are available in non-standard dimensions for no extra charge due to their atypicality. The charge concerns only doors: higher than 210 cm and wider than 102 cm (for 72 and 82 mm thick). Attention: side light imitation of a door leaf is fixed on hinges.



P9 + FIXED SIDE DOOR LEAF [IMITATING DOOR LEAF]

Door width (cm)	Door height (cm)	
	with aluminium threshold	with wooden threshold
160	208,2	210



P47 + OPENING GLASS SIDE DOOR LEAF

Door width (cm)	Door height with wooden threshold (cm)
160	210



P21 + FIXED SIDE DOOR LEAF [IMITATING DOOR LEAF]

Door width (cm)	Door height (cm)	
	with aluminium threshold	with wooden threshold
160	208,2	210



P55 + FIXED GLASS IN-FRAME SIDE DOOR LEAF

Door width (cm)	Door height (cm)	
	with aluminium threshold	with wooden threshold
140	208,2	210

EXPANSION CAPABILITIES



P46 + FIXED GLASS IN-FRAME SIDE DOOR LEAF

Door width (cm)	Door height (cm)	
	with aluminium threshold	with wooden threshold
140	208,2	210



P137 + FIXED GLASS IN-FRAME SIDE DOOR LEAFS

Door width (cm)	Door height (cm)	
	with aluminium threshold	with wooden threshold
180	208,2	210



P45 + FIXED GLASS IN-FRAME SIDE DOOR LEAFS

Door width (cm)	Door height (cm)	
	with aluminium threshold	with wooden threshold
160	208,2	210

ATTENTION: fixed in-frame side door leaf
– glazing – secure glass set 44 mm REFLEX BROWN

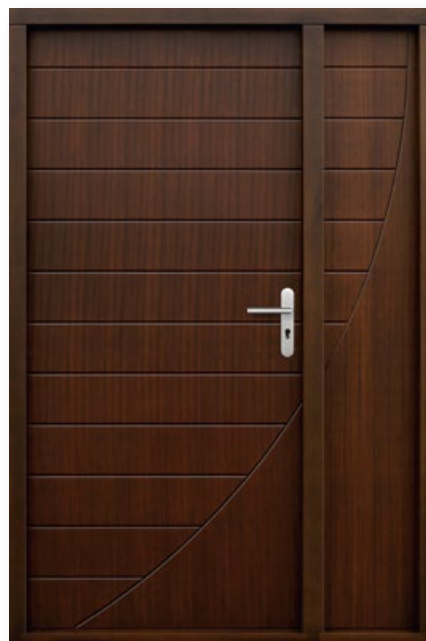

P59 + FIXED SIDE DOOR LEAF [IMITATING DOOR LEAF]

Door width (cm)	Door height (cm)	
	with aluminium threshold	with wooden threshold
140	208,2	210

ERKADO doors are available in non-standard dimensions for no extra charge due to their atypicality. The charge concerns only doors: higher than 210 cm and wider than 102 cm (for 72 and 82 mm thick). Attention: side light imitation of a door leaf is fixed on hinges.



P42 + FIXED SIDE DOOR LEAF [IMITATING DOOR LEAF] + TOP LIGHT

Door width (cm)	Door height (cm)	
	with aluminium threshold	with wooden threshold
160	240	240



P28 + FIXED SIDE DOOR LEAF [IMITATING DOOR LEAF] + TOP LIGHT

Door width (cm)	Door height (cm)	
	with aluminium threshold	with wooden threshold
180	240	240



P34 + FIXED GLASS SIDE DOOR LEAFS [IMITATING DOOR LEAF]

Door width (cm)	Door height (cm)	
	with aluminium threshold	with wooden threshold
190	208,2	210



P28 + FIXED SIDE DOOR LEAF [IMITATING DOOR LEAF]

Door width (cm)	Door height (cm)	
	with aluminium threshold	with wooden threshold
140	208,2	210

Attention: fixed side door leaf is fitted on the hinges

EXPANSION CAPABILITIES



P107 + FIXED GLASS IN-FRAME SIDE DOOR LEAF

Door width (cm)	Door height (cm)	
	with aluminium threshold	with wooden threshold
150	208,2	210



P132 + FIXED SIDE DOOR LEAF [IMITATING DOOR LEAF]

Door width (cm)	Door height (cm)	
	with aluminium threshold	with wooden threshold
160	208,2	210



P147 + FIXED GLASS IN-FRAME SIDE DOOR LEAFS

Door width (cm)	Door height (cm)	
	with aluminium threshold	with wooden threshold
160	208,2	210



P98 + FIXED SIDE DOOR LEAF [IMITATING DOOR LEAF]

Door width (cm)	Door height (cm)	
	with aluminium threshold	with wooden threshold
160	208,2	210

ERKADO doors are available in non-standard dimensions for no extra charge due to their atypicality. The charge concerns only doors: higher than 210 cm and wider than 102 cm (for 72 and 82 mm thick).. Attention: side light imitation of a door leaf is fixed on hinges.



P68 + FIXED GLASS IN-FRAME SIDE DOOR LEAF

Door width (cm)	Door height (cm)	
	with aluminium threshold	with wooden threshold
140	208,2	210



P8 + FIXED SIDE DOOR LEAF [IMITATING DOOR LEAF]

Door width (cm)	Door height (cm)	
	with aluminium threshold	with wooden threshold
160	208,2	210



P141 + FIXED SIDE DOOR LEAF [IMITATING DOOR LEAF]

Door width (cm)	Door height (cm)	
	with aluminium threshold	with wooden threshold
160	208,2	210



P83 + FIXED SIDE DOOR LEAF [IMITATING DOOR LEAF]

Door width (cm)	Door height (cm)	
	with aluminium threshold	with wooden threshold
140	208,2	210

Dimensions

THE REBATE ON THE DOOR EDGE 18 mm

advantages:

- better sealing of the door leaf to the frame
- full coverage of catch plates

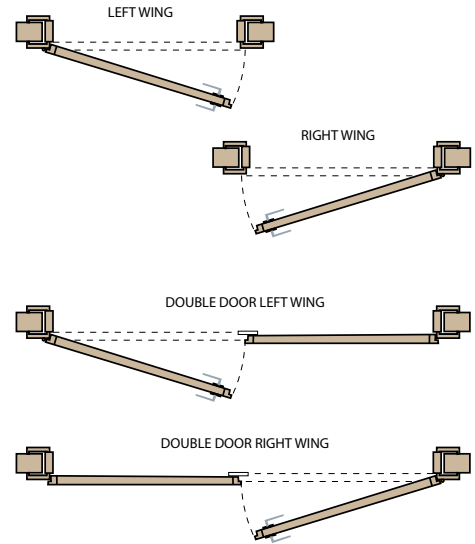
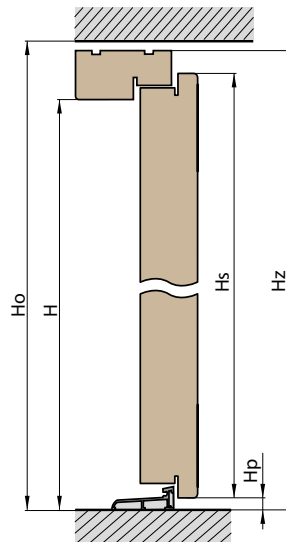
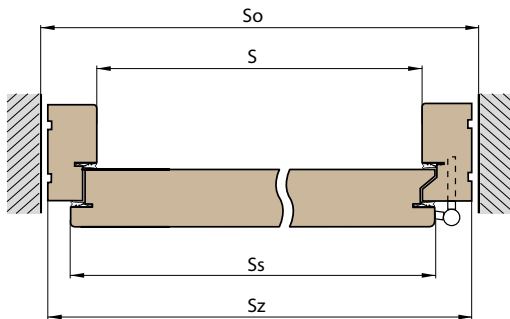

- S** - clear frame opening width [mm]
- So** - wall hole width [mm]
- Ss** - door leaf width [mm]
- Sz** - total door leaf width [mm]
- Ho** - wall hole height [mm]

- H** - clear frame opening height [mm]
- Hs** - door leaf height [mm]
- Hz** - total door height [mm]
- Hpa** - aluminium threshold height [mm]
- Hpd** - wooden threshold height [mm]

TECHNICAL DATA

DIMENSIONS WITH ALUMINIUM THRESHOLD										
Leaf thickness	Size	S	So	Ss	Sz	H	Ho	Hs	Hz	Hpa ALU (aluminium threshold)
72 mm 82 mm	„80“	800	940	841	920	2002	2100	2041	2082	20
	„90“	900	1040	941	1020	2002	2100	2041	2082	20
	„100“	1000	1140	1041	1120	2002	2100	2041	2082	20
102 mm	„80“	800	980	871	960	2002	2120	2056	2102	20
	„90“	900	1080	971	1060	2002	2120	2056	2102	20
	„100“	1000	1180	1071	1160	2002	2120	2056	2102	20

DIMENSIONS WITH WOODEN THRESHOLD										
Leaf thickness	Size	S	So	Ss	Sz	H	Ho	Hs	Hz	Hpd WOOD (wooden threshold)
72 mm 82 mm	„80“	800	940	841	920	2002	2120	2041	2100	40
	„90“	900	1040	941	1020	2002	2120	2041	2100	40
	„100“	1000	1140	1041	1120	2002	2120	2041	2100	40
102 mm	„80“	800	980	871	960	2002	2140	2056	2120	40
	„90“	900	1080	971	1060	2002	2140	2056	2120	40
	„100“	1000	1180	1071	1160	2002	2140	2056	2120	40

ADDITIONAL CHARGES FOR

ADDITIONAL CHARGES FOR NONSTANDARD DOORS	
No.	Description
1.	No charges for doors narrower than 102 cm and lower than 210 cm (72 and 82 mm thick)
2.	CHARGE TO WIDER DOORS:
a)	door wider up to total width 106 cm [72 mm thick, 82 mm thick]
b)	door wider up to total width 110 cm [102 cm thick]
c)	door of total width from 107 cm to 111 cm [82 mm thick]
d)	door of total width from 111 cm to 115 cm [102 cm thick]
e)	charge to door 100 cm wide [112x208,2/210 - 72 mm thick and 82 mm thick], [116x210,2/212 - door 102 mm thick]
3.	3. CHARGE TO HIGHER DOORS [EXCLUDING TOPLIGHTS]:
a)	within scope from 210 cm up to 215 cm + 15% value of typical doors
b)	within scope from 215 cm up to 224 cm + 30% value of typical doors
4.	SIDE DOOR LEAF AT TOTAL WIDTH UP TO 150 cm
a)	open with glazing + 75% value of single door leaf
b)	open without glazing + 70% value of single door leaf
c)	fixed imitation of door leaf without glazing + 50% value of single door leaf
d)	fixed imitation of door leaf with glazing + 60% value of single door leaf
e)	fixed-in-frame mahogany-meranti (not depending on total width)
f)	fixed-in-frame oak (not depending on total width)
g)	fixed-in-frame pine (not depending on total width)
5.	SIDE DOOR LEAF AT TOTAL WIDTH FROM 151 UP TO 170 cm:
a)	open with glazing + 95% value of single door leaf
b)	open without glazing + 90% value of single door leaf
c)	fixed imitation with glazing + 85% value of single door leaf
d)	fixed imitation without glazing + 80% value of single door leaf
e)	fixed-in-frame mahogany-meranti (not depending on total width)
f)	fixed-in-frame oak (not depending on total width)
g)	fixed-in-frame pine (not depending on total width)
6.	ADDITIONAL CHARGE TO DOUBLE DOORS OF WIDTH FROM 171 cm TO 196 cm IS + 110% VALUE OF SINGLE DOOR LEAF
7.	FIXED DOOR LEAF AND TOPLIGHTS
a)	fixed-in-frame mahogany-meranti (not depending on total width)
b)	fixed-in-frame oak (not depending on total width)
c)	fixed-in-frame pine (not depending on total width)
d)	fixed imitation of door leaf up to total width 250 cm + 50% value of door leaf
8.	CHARGES - COLOUR
a)	RAL Colour Palette [single door leaf], apart from RAL9016 [white] and RAL 7016 [charcoal]
b)	double-colour doors
9.	Charge for changing glazing
a)	fixed charge for modification in glazing e.g. two-way mirror, milk glass, sanded glass, P4
10.	Thickening of the frame: 10 mm/ l.m. (pine, oak, meranti)
11.	Frame extension to wall width in the form of the tunnel:
a)	mahogany-meranti material for each centimetre mahogany-meranti adjustable cover
b)	oak material for each centimetre oak adjustable cover
c)	pine material for each centimetre pine adjustable cover
12.	MASKING TRIMS 10 mm x 60 mm PER SET ON ONE SIDE
a)	mahogany-meranti
b)	oak
c)	pine
13.	QUARTER ROUNDS 10 mm x 25 mm PER SET ON ONE SIDE
a)	mahogany-meranti
b)	oak
c)	pine
14.	ALUMINIUM GUTTER DRIP DOORS OPENING INSIDE THICKNESS 82 mm AND 102 mm
a)	wooden gutter drip to doors opening inside thickness 72 mm

ACCESSORIES

PEEPHOLE



LOCKS

MULTI-POINT LOCK GU SECURITY AUTOMATIC

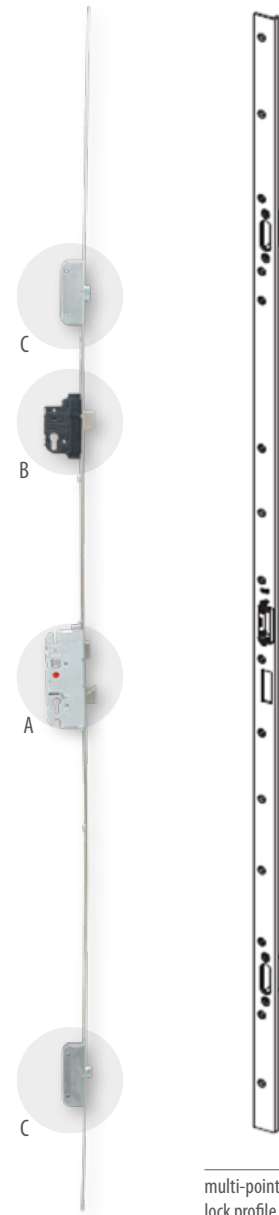
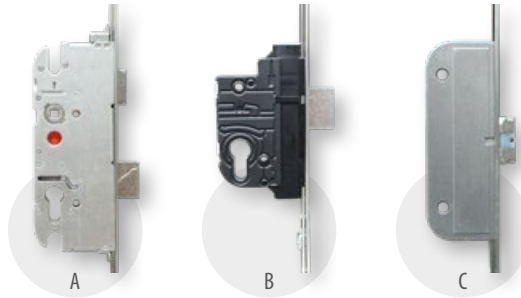

multi-point lock profile

FRAME EXTENSION



WHEN APPLYING MULTI-POINT LOCK THE EXTERIOR DOORS MEET THE REQUIREMENTS FOR SECOND CLASS RESISTANCE TO BURGLARY

MULTI-POINT LOCK WITH ONE CYLINDER
thickness 82 mm and 102 mm - standard
thickness 72 mm - charged

FOR TWO CYLINDERS
thickness 102 mm - charged
thickness 72 mm - charged



TKZ HINGES
in patina and nickel
thickness 102 mm - standard
thickness 72 mm and 82 mm
- charged

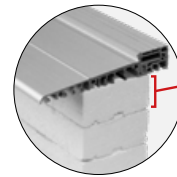

THERMOINSULATING STRIP
H: 30 mm x W: 64 mm
- extra charged

1 piece

HINGE CASINGS



AXA HINGE CASINGS aluminium



IRON HINGE CASING TKZ
chrome gloss

FERRED ALARM SWITCH



ADAPTER SWITCH



OVERHEAD DOOR-CLOSER



HIDDEN OVERHEAD DOOR-CLOSER

Options for door-closer:

- opening borderer - additionally charged
- opening lock-up - additionally charged

ELECTRIC STRIKE



ELECTRIC STRIKE
comes only with the multi-point lock
with 1 or 2 cylinders

CLEAING KIT FOR REGENERATING AND MAINTAINING DOOR SURFACES



Taking regular care of wooden doors seems a crucial element for the door surface to be of great condition.

To keep the costs at the lowest level, ADLER released the Cleaning Kit that is highly effective, easy to use and user friendly.

No brush or sandpaper is required once applying Cleaning Kit. Thanks to it all microscopic cracks and laasures pores become filled in and consequently it extends durability of the laasures surfaces.

ACCESSORIES

■ ELECTRONIC SYSTEM OF DOOR OPENING

Bi-metric door lock is a contemporary solution thanks to which we do not have to be afraid of losing keys to our door.

Bio-metric lock operates with our fingerprints. The lock identifies the owner, or other person authorised to enter home, by scanning the fingerprints and comparing them to the patterns from database. The system can deposit and read 150 code patterns thanks to which all potential inhabitants may open the door without having a regular key.

Bio-metric locks are fully and highly secure. Fingerprints are unique and constant-coded and counterfeiting such a „key“ is not possible.

Additionally, the reader of the lock does not store the fingerprints but a respective to them binary codes on the basis of which the pattern of fingerprints cannot be recreated.

Aside from standard option, bio-metric locks can be additionally connected to burglary alarm system.

Electronic system of door opening with the fingerprints reader or numeric bluetooth keyboard@Code, RFID reader

■ DIGITAL PEEP-HOLE



MODEL DDS 2

- can save up to 50 snaps from the camera fixed in peep-hole
- provides date and time of the snap
- can be equipped with 8 GB memory card
- default ringtones



fingerprint reader



numeric keyboard



bluetooth keyboard



RFID reader

PROJECT FLEXIBILITY

DESIGN **YOUR OWN** EXTERIOR 'P' DOORS

Feel invited to design **your own model of exterior P doors.**

Technologies used by ERKADO allow to make practically all suggested patterns. Therefore it is possible to personalise Your own door preferences such as width [side doors], height [toplights], style, pattern [even the most sophisticated milling], colour [offered palette of colours and RAL colours].

Doors of personalised character are quoted individually.

Make your own exterior door with us!

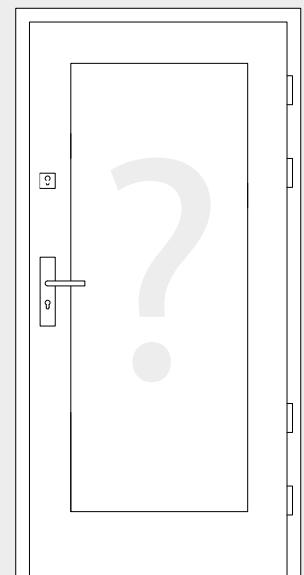

ACCESSORIES



■ KNOBS

AXA



NIAGARA knob and face
primary security class
in nickel, inox, patina



ODIN knob and face
3rd security class
in nickel, inox, patina



ROYAL knob and face
3rd security class
in nickel, inox, patina, black



HAGA knob and face
primary security class
in nickel, inox, patina, black



PRESTIGE knob and face
3rd security class
in nickel, inox, patina, black



JUPITER FLEX knob and face
3rd security class
in nickel, inox, patina, black



QUEBEC knob and face
3RD SECURITY CLASS
in nickel, inox, patina

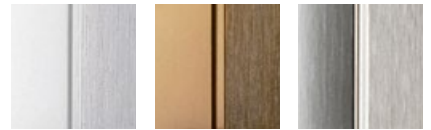

nickel

patina

inox

Metal-Bud



TOTAL knob and face
in inox, patina, black



METRO knob and face
in stainless



ZEUS knob and face
in inox, patina

■ CYLINDERS



ACCESSORIES

■ stainless holders

INOX or painted black (add. charged)

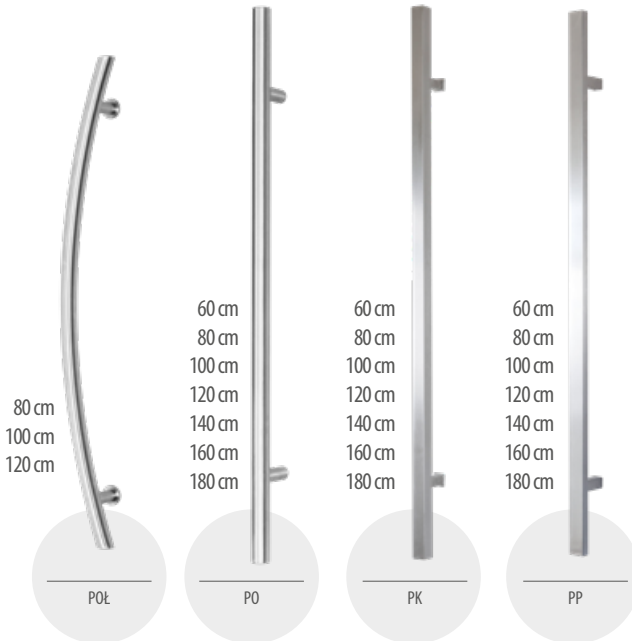

„function of door opening by means of electric strike or engine“ is additionally charged and comes with holder button

version 1:

The price includes:
 – holder button
 – wireless contact
 – electric strike
 – adapter

version 2:

The price includes:
 – holder button
 – GU lock engine
 – electric strike
 – adapter

■ By selecting doors with holder You can choose among three ways of opening:

1. with key
2. with electric strike or key by day-night function
3. with button or key

■ door handle and rosette

to one-side door holders



AXA SOLO knob and face in inox, black



AXA SLIM knob and face in inox



AXA SLIM faces to one-side door holders

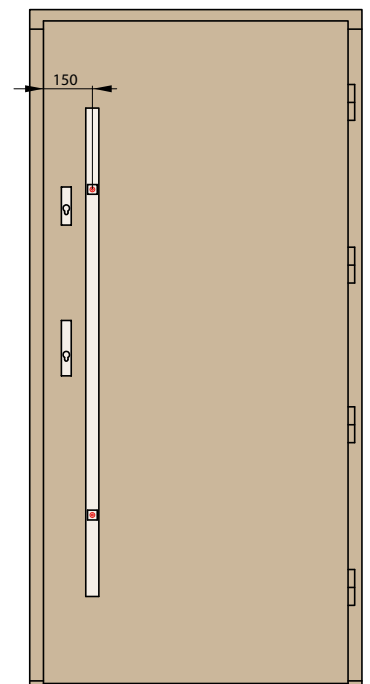

ASSEMBLY



ERKADO DYSTRYBUCJA Sp. z o.o. spółka komandytowa

Chwałowice 156
37-455 Radomyśl n/Sanem
POLAND

NIP 8652562260
e-mail: dz@erkado.pl
www.erkado.pl

EXTERIOR DOORS

tel. +48 15/ 845 33 88
fax +48 15/ 845 34 05

INTERIOR DOORS

tel. +48 15/ 838 10 57
fax +48 15/ 838 18 84

www.erkado.pl

The guarantee and assembly cards are attached to the product.
This catalogue is only of the informative usage and includes up-to-date range of available products.
The producer has the right to change the prices and the range of available goods without official notification.
The colour samples can differ in reality with those presented in this catalogue. Please consult the colours with the original samples that can be accessed at our distributors.
We have the right to printing errors.

CE CERTIFICATE
FSC CERTIFICATE

Scan code and download this catalogue
on to Your smartphone/tablet [pdf]



Catalogue of
EXTERIOR DOORS



Catalogue of
INTERIOR DOORS